

ADAM[®]

Eclipse[®]

Set-Up Guide

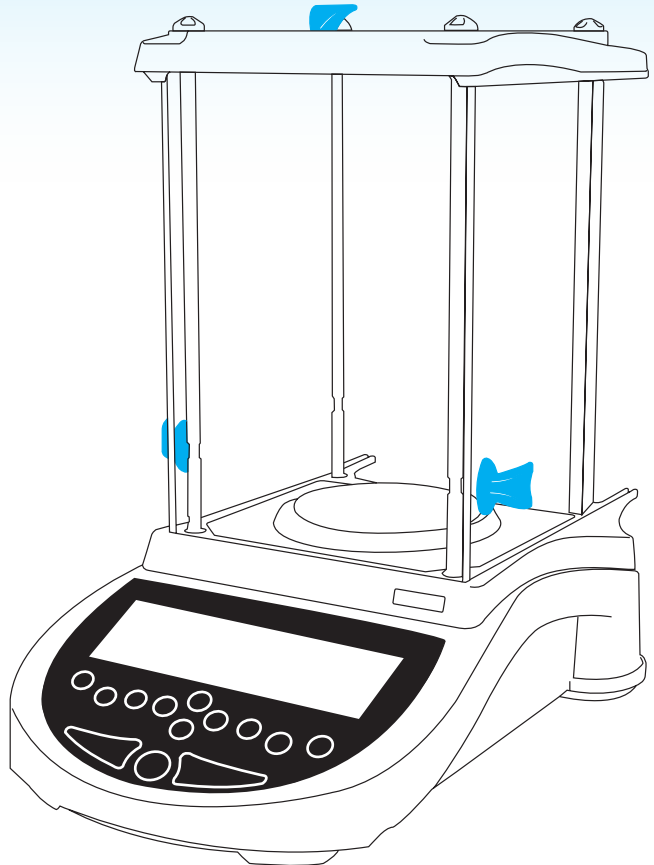

Part # 3.01.6.6.12085 , Rev 1.0, Sep 2015

www.adamequipment.com

Precision - 1mg (0.001g)

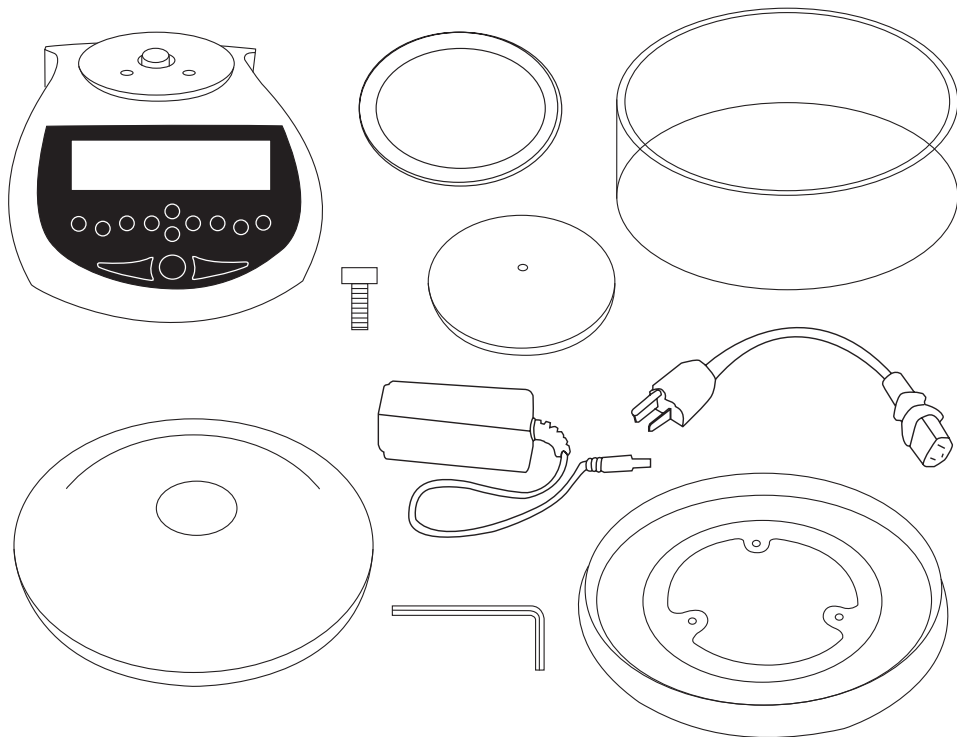

Precision - 10mg (0.01g)

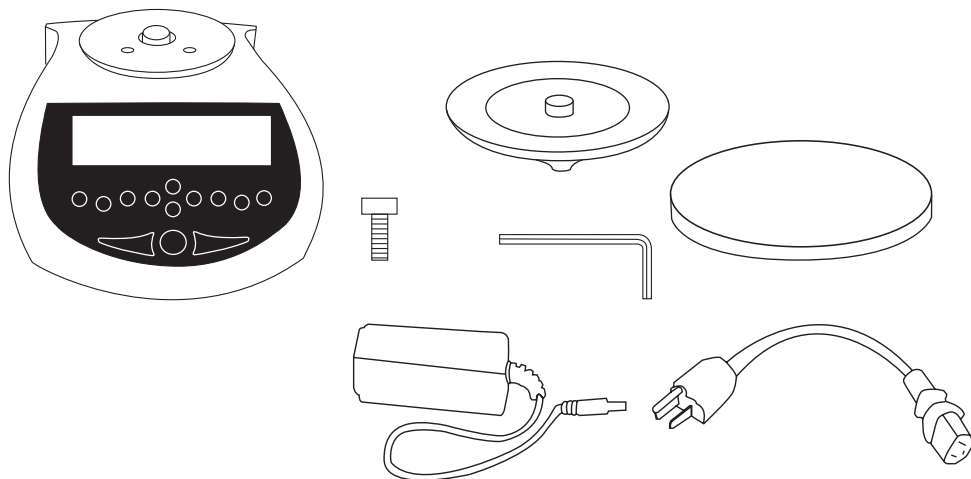

Analytical - 0.1mg (0.0001g)

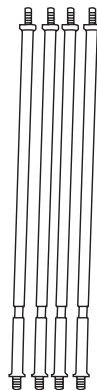
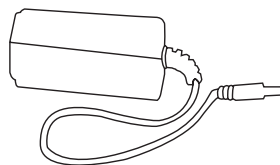
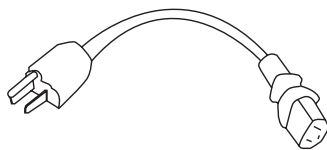
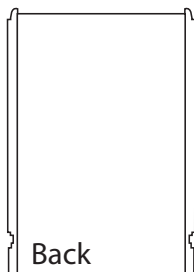
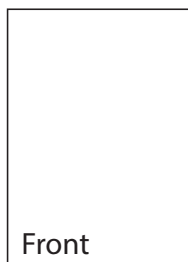
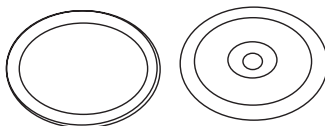
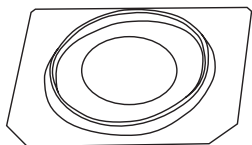
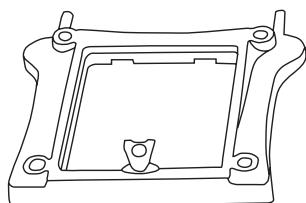
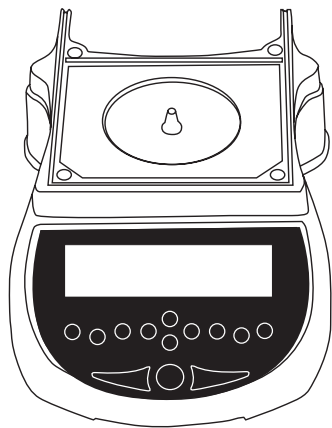

Front

Back



Set Up

Analytical Remove any transit packaging and protection pieces

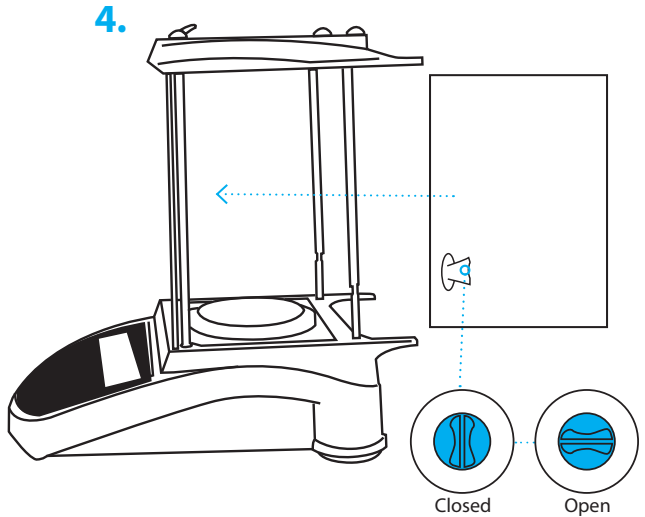
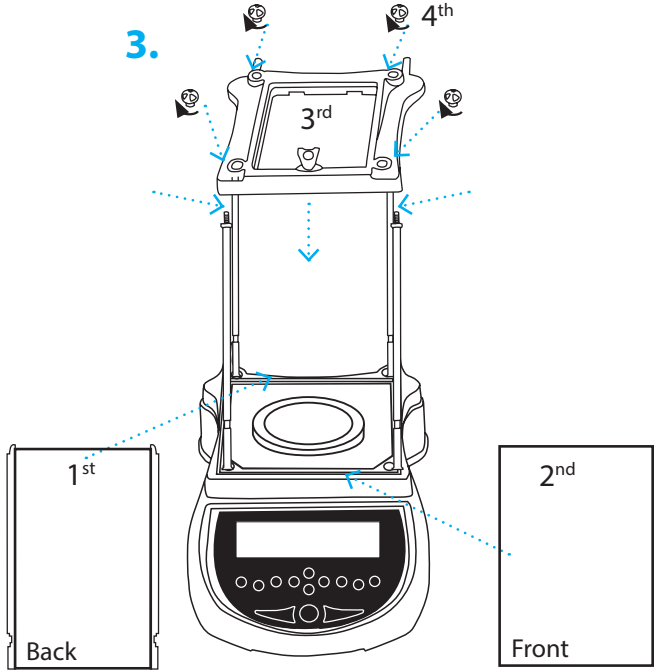
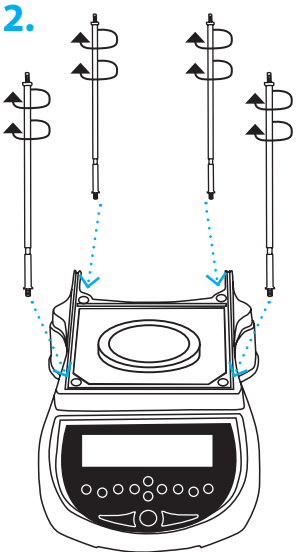
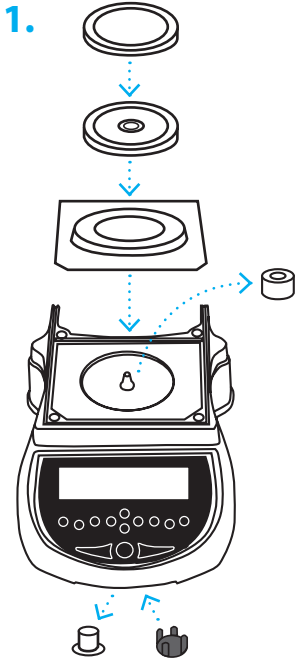

For Eclipse assistance, scan QR code or visit
www.adamequipment.com/Eclipsesupport

Precision

Remove any transit packaging and protection pieces

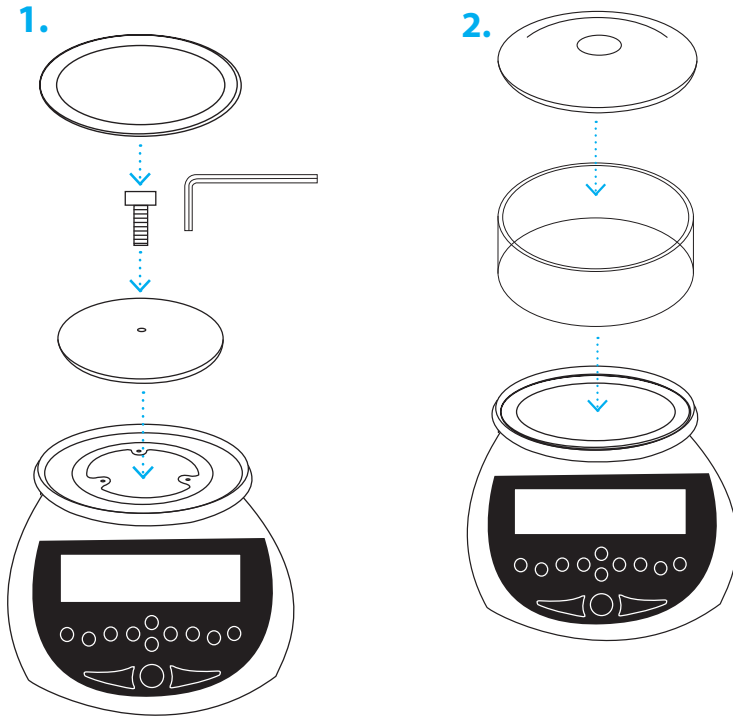

Precision - Top Loader

Remove any transit packaging and protection pieces

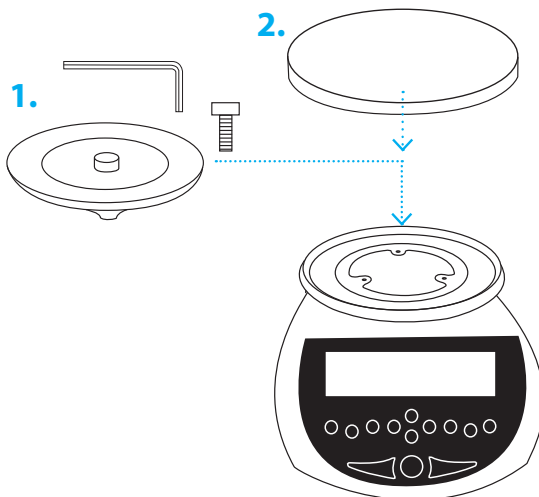

Locating the balances

1.

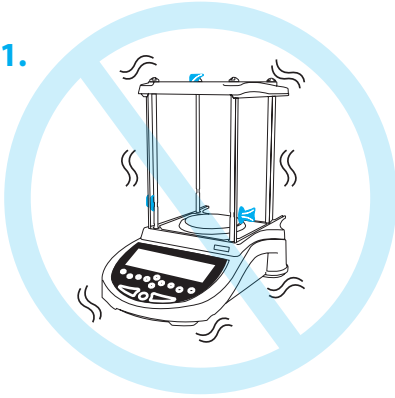

Avoid Vibrations

2.

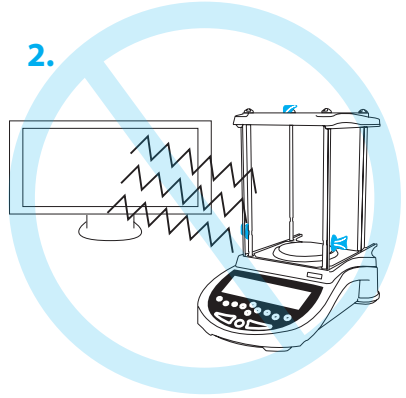

Static Free Area

3.

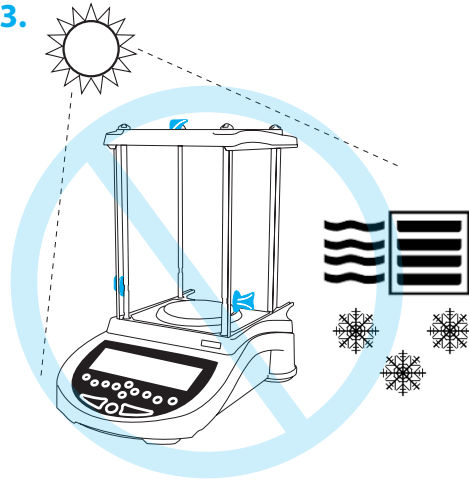

Avoid Extreme Temperatures

4.

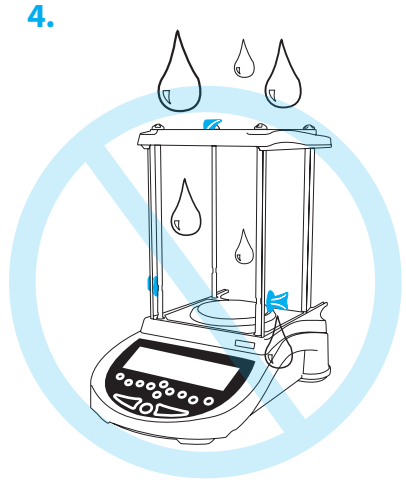

Avoid Water Contact

Turning on your balance (warm up)

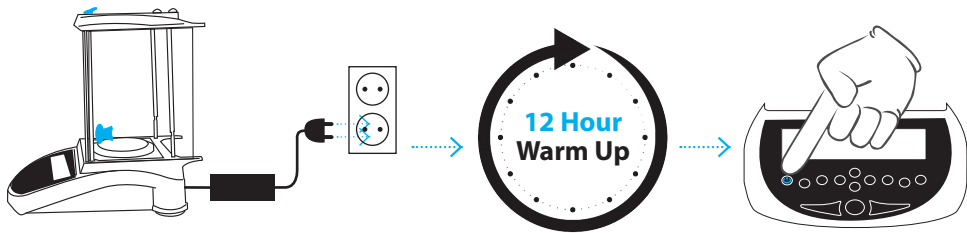

The balance must be plugged into the mains power and turned on for a minimum of 12 hours, prior to any calibration and use. The balance should then be calibrated before use.

For operating and set up videos as well as a complete user's manual - go to our Eclipse support page: www.adamequipment.com/EclipseSupport

External Calibration

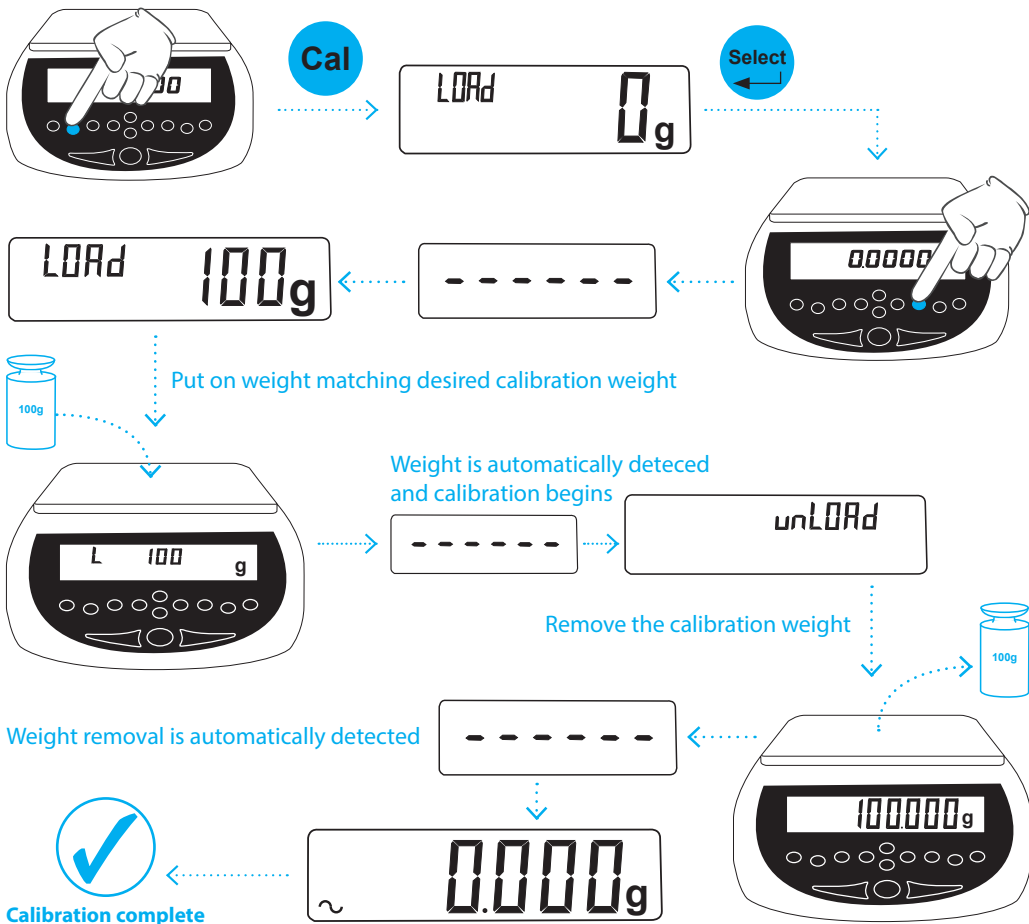

Weighing

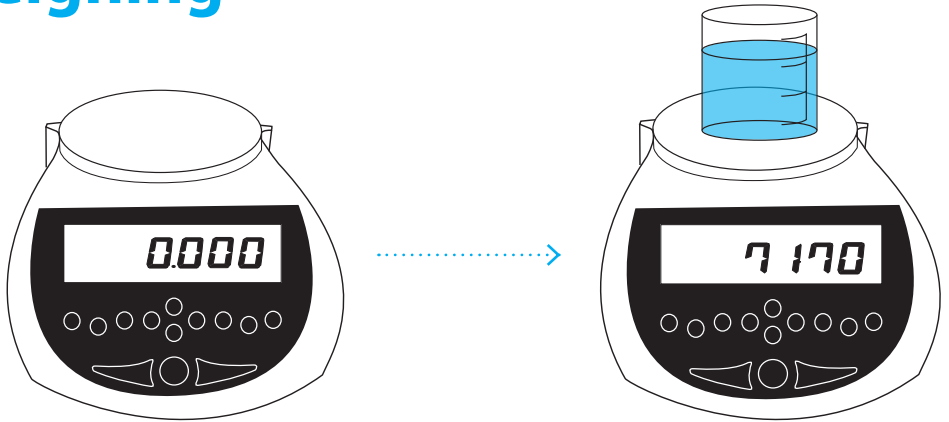

Changing weighing units

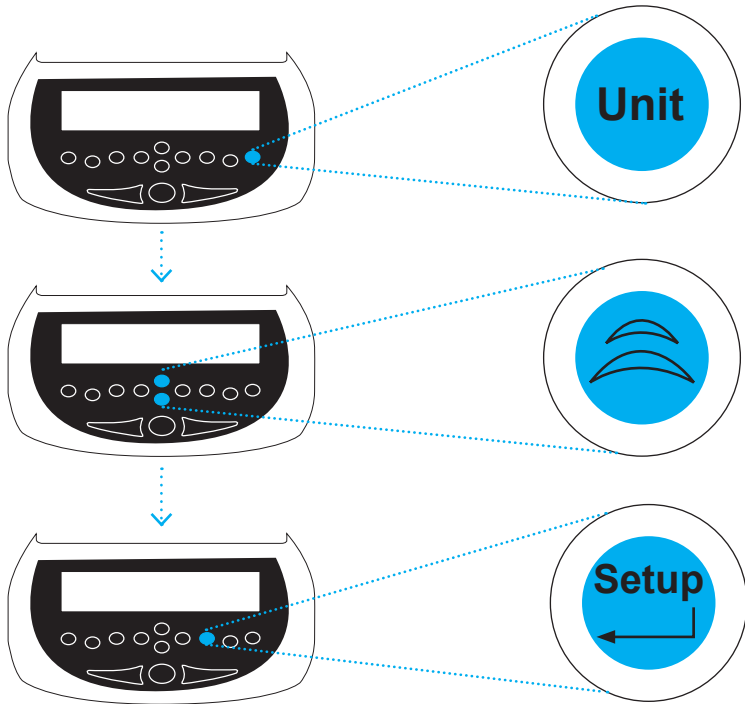

g, kg*, mg*, ct, GN, N, oz, ozt, dwt, lb*, dr, mm, tl T, tl H, tl S, tl, ti, T, Cus Unit
*kg, lb available for Precision only, mg available for Analytical only.

Taring the balances

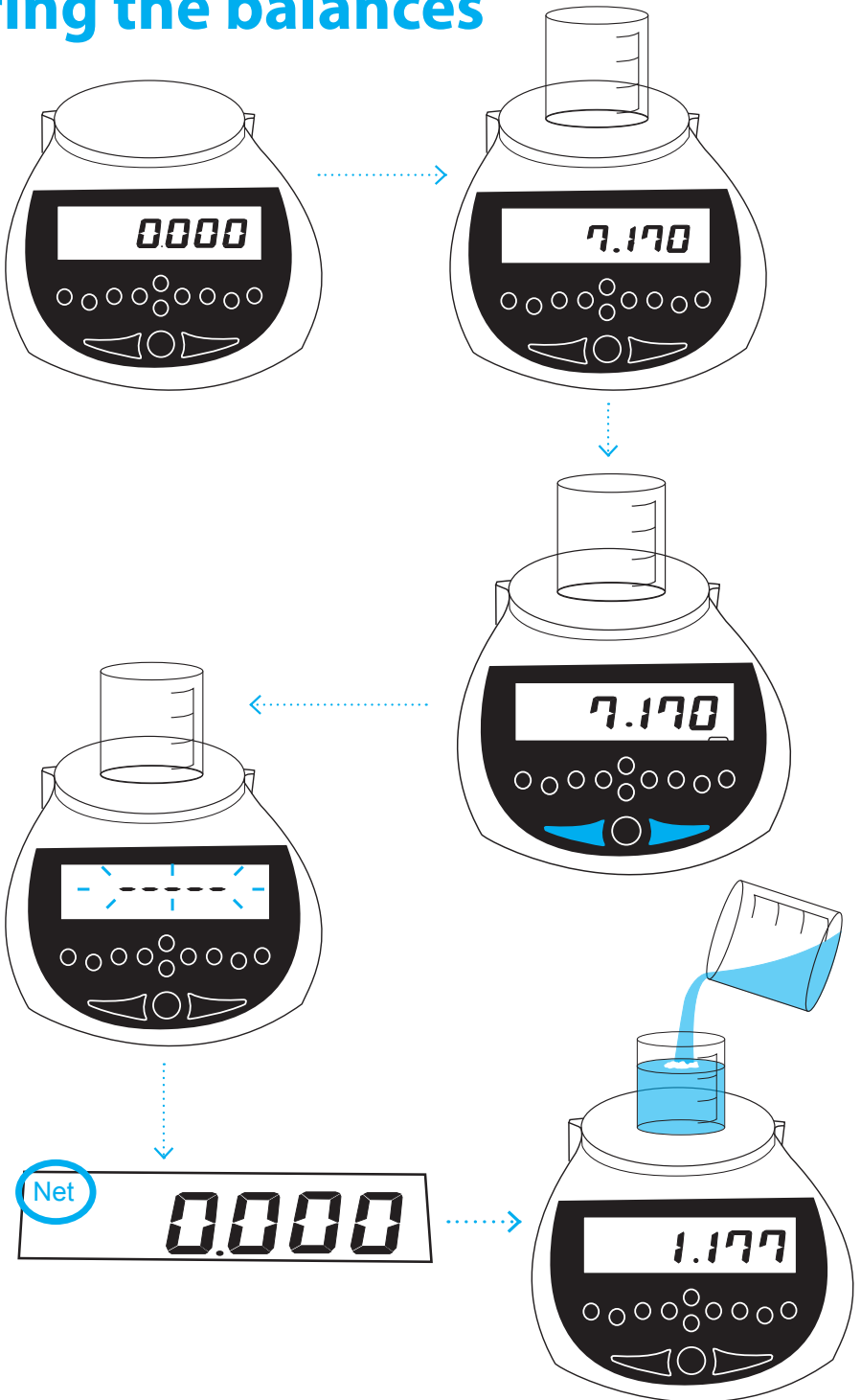

WARRANTY INFORMATION

Adam Equipment offers Limited Warranty (Parts and Labour) for any components that fail due to defects in materials or workmanship. Warranty starts from the date of delivery.

During the warranty period, should any repairs be necessary, the purchaser must inform its supplier or Adam Equipment. The company or its authorised technician reserves the right to repair or replace the components at the purchaser's site or any of its workshops depending on the severity of the problems at no additional cost. However, any freight involved in sending the faulty units or parts to the service centre will be borne by the purchaser.

The warranty will cease to operate if the equipment is not returned in the original packaging and with correct documentation for a claim to be processed. All claims are at the sole discretion of Adam Equipment.

This warranty does not cover equipment where defects or poor performance is due to misuse, accidental damage, exposure to radioactive or corrosive materials, negligence, faulty installation, unauthorised modifications or attempted repair or failure to observe the requirements and recommendations as given in this User Manual.

This product may include a rechargeable battery that is designed to be removed and replaced by the user. Adam Equipment warrants that it will provide a replacement battery if the battery manifests a defect in materials or workmanship during the initial period of use of the product in which the battery is installed.

As with all batteries, the maximum capacity of any battery included in the product will decrease with time or use, and battery cycle life will vary depending on product model, configuration, features, use, and power management settings. A decrease in maximum battery capacity or battery cycle life is not a defect in materials or workmanship, and is not covered by this Limited Warranty.

Repair carried out under the warranty does not extend the warranty period. Components removed during the warranty repairs become the company property.

The statutory rights of the purchaser are not affected by this warranty. In the event of dispute then the terms of this warranty are governed by UK law. For complete details on Warranty Information, see the terms and conditions of sale available on our web-site.



Manufacturer's Declaration of Conformity

Adam Equipment Co. Ltd.
Maidstone Road, Kingston
Milton Keynes, MK10 0BD
United Kingdom

www.adamequipment.com

This product has been manufactured in accordance with the harmonised European standards, following the provisions of the below stated directives:

2004/108/EC, Electro Magnetic Compatibility Directive	Standard EN61326-1:2013, Electrical Equipment for Measurement, Control and Laboratory Use – EMC requirements – Part 1: general requirements.
2006/95/EC, Low Voltage Directive	Standard EN61010-1:2010, Safety requirements for measurement, control and laboratory use equipment – Part 1: General requirements.
2011/65/EC, RoHS, on the Restriction of the use of certain hazardous substances in electrical and electronic equipment (recast)	Restricted substances referred to in Article 4(1) and maximum concentration values tolerated by weight in homogeneous materials do not exceed prescribed limits.
2009/23/EC Non Automatic Weighing Equipment Directive	Standard EN 45501:1992, AC:1993 (applies only to certified non-automatic weighing instruments)

FCC COMPLIANCE

This equipment has been tested and found to comply with the limits for a Class A digital device, pursuant to Part 15 of the FCC Rules. These limits are designed to provide reasonable protection against harmful interference when the equipment is operated in a commercial environment. The equipment generates, uses, and can radiate radio frequency energy and, if not installed and used in accordance with the instruction manual, may cause harmful interference to radio communications. Operation of this equipment in a residential area is likely to cause harmful interference in which case the user will be required to correct the interference at his own expense.

Shielded interconnect cables must be employed with this equipment to insure compliance with the pertinent RF emission limits governing this device.

Changes or modifications not expressly approved by Adam Equipment could void the user's authority to operate the equipment.

WEEE COMPLIANCE



Ni-MH Battery
Remove and recycle

DO NOT DISPOSE OF IN GENERAL WASTE

Any Electrical or Electronic Equipment (EEE) component or assembly of parts intended to be incorporated into EEE devices as defined by European Directive 2012/19/EU must be recycled or disposed of using techniques that do not introduce hazardous substances harmful to our health or the environment as listed in Directive 2011/65/EC or amending legislation.

Battery disposal must be performed according to local laws and restrictions.

ADAM EQUIPMENT is an ISO 9001:2008 certified global company with more than 40 years experience in the production and sale of electronic weighing equipment.

Adam products are predominantly designed for the Laboratory, Educational, Medical, retail and Industrial Segments. The product range can be described as follows:

- Analytical and Precision Balances
- Compact and Portable Balances
- High Capacity Balances
- Moisture analysers / balances
- Mechanical Scales
- Counting Scales
- Digital Weighing/Check-weighing Scales
- High performance Platform Scales
- Crane scales
- Medical Scales
- Retail Scales for Price computing

For a complete listing of all Adam products visit our website at www.adamequipment.com

© Copyright by Adam Equipment Co. Ltd. All rights reserved.

No part of this publication may be reprinted or translated in any form or by any means without the prior permission of Adam Equipment.

Adam Equipment reserves the right to make changes to the technology, features, specifications and design of the equipment without notice.

All information contained within this publication is to the best of our knowledge, timely, complete and accurate when issued. However, we are not responsible for misinterpretations which may result from the reading of this material.

The latest version of this publication can be found on our Website.

www.adamequipment.com

Serial No.
Model No.
Date Purchased.

Register product online at www.adamequipment.com/register